

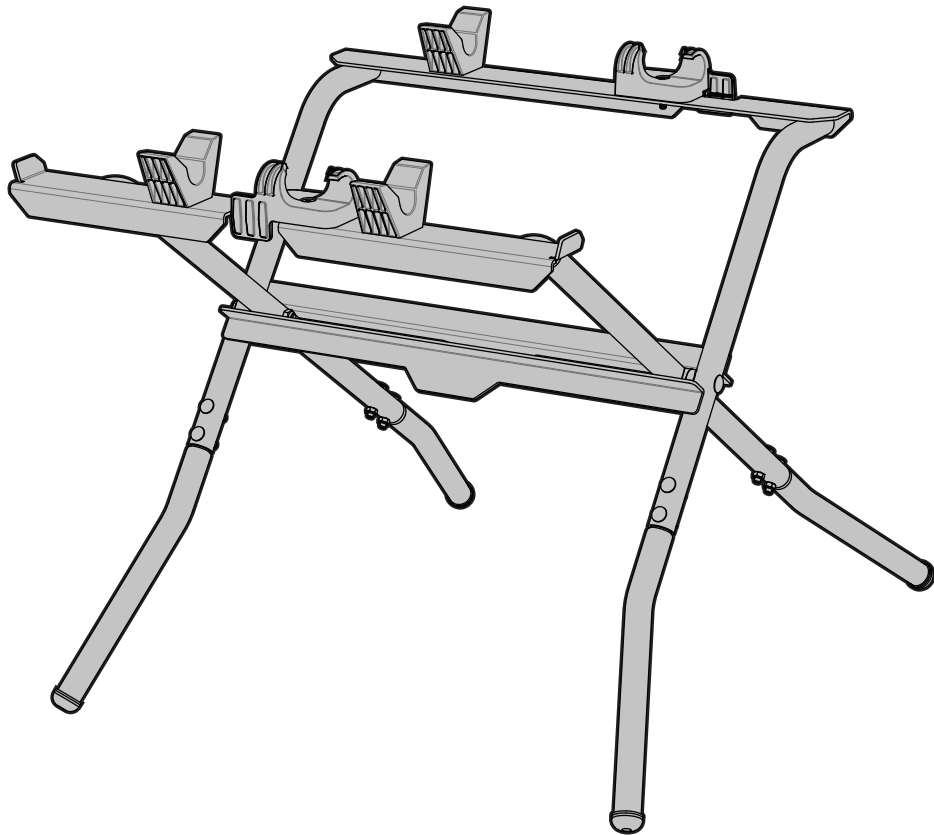

Owner's Manual

Compact Table Saw - Folding Stand

Model Number: CTS-FS





Copyright SawStop, LLC
All Rights Reserved.

Published, October 2021

Updates of this manual may be available at www.SawStop.com

Symbols

	DEFINITION
	Indicates read the instructions.
	Warning of general danger.
	Indicates additional information or tip.

Parts

Before beginning assembly or disposing of packaging, confirm you have all parts:

- 1 stand assembly
- 4 lower legs
- 8 carriage bolts
- 8 lock nuts





If missing any parts, contact SawStop (see pg. 4).

You will also need a 10 mm socket or end wrench.





Safety



Read and understand this owner's manual and all safety warnings before using the stand. Failure to follow instructions or heed warnings may result in serious personal injury or property damage. Save these instructions and refer to them whenever necessary. Read through the instructions before assembly or use.

-  Attach the lower legs and make sure the fasteners are tight before using the saw on the stand. Periodically make sure fasteners are tight and that the clamps and cradles are solidly attached to the frame and functioning properly. Periodically inspect the stand for damage.
-  Place and use the stand on a solid level surface. Place the stand in the working location before mounting the saw. Never stand on or climb on the stand.
-  Turn off and unplug the Compact Table Saw before mounting on the stand or removing from the stand.
-  Mount the saw with the front of the saw at the front of the stand (see the Mount Saw section). The clamps will not lock with the saw reversed. Use the stand only with the Compact Table Saw.
-  Use only SawStop replacement parts.

Assemble Stand

-  **Before using the stand, you must attach the four lower leg pieces. The lower legs must point outwards, angling out away from the stand.**
-  The four lower leg pieces are identical and can be mounted on any of the upper legs.
-  The eight carriage bolts can be inserted through the tubes in either direction; in these instructions, the heads of the bolts face outwards when the stand is in the working position.
-  **Make sure the carriage bolts are fully inserted in the upper tubes—the square shoulders of the bolts fit in the square holes of the outer tubes.**

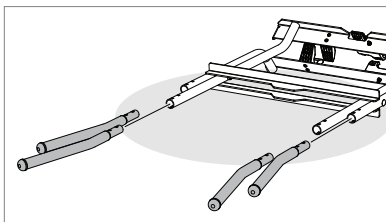

The stand is mostly assembled from the factory. You will only need to attach the lower legs to complete the assembly.

1. Lay the stand in the closed position flat on the floor or ground.
2. Insert the four lower legs into the upper legs. Make sure the angled portion of each leg points outwards.

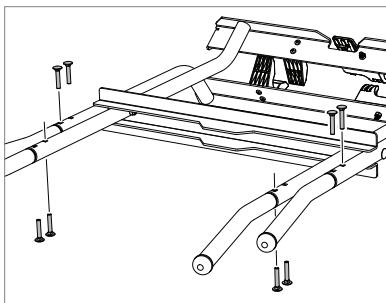

3. Insert the eight carriage bolts through the holes in the legs. You can insert the bolts from either side of the tubes.

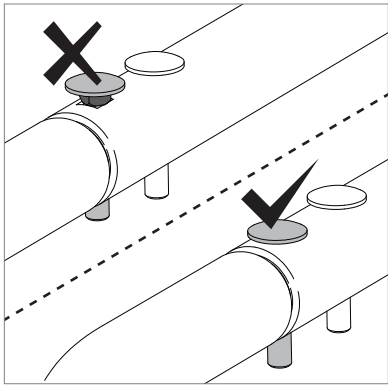

3. (cont.) Make sure the square shoulders of the bolts are inserted and mated to the square holes in the upper legs.

i You can also attach one bolt and one lock nut at a time to make sure each bolt stays in place while you attach the next. Hand-tighten each lock nut, and then tighten all at the same time.

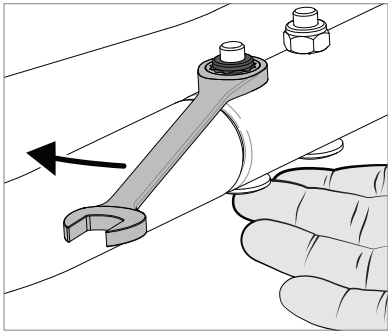

4. Thread the eight lock nuts onto the bolts, and then tighten. Do not over-tighten.

Mount Saw

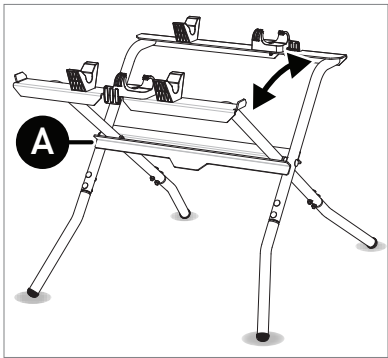

1. Open the stand, and then place on a solid level floor or solid level ground. The stand is fully opened when the center cross brackets (A) will not allow the stand to unfold any farther.

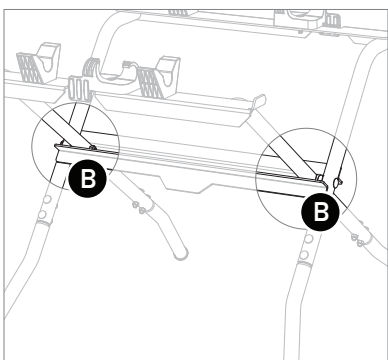

⚠ Be aware of pinch hazards at the pivot points (B) of the assembly.

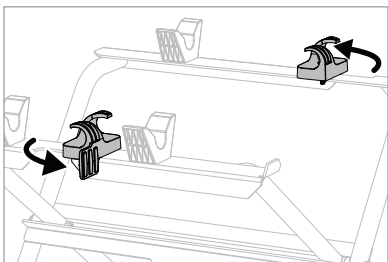

2. Open the clamps: pivot the front and rear clamps 90° counterclockwise.

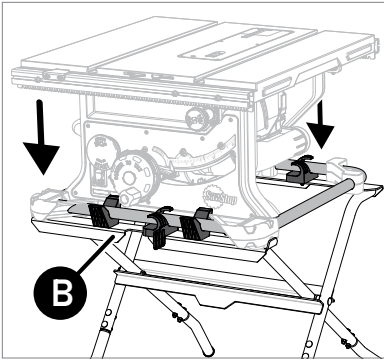

The cross plate with two cradles and one clamp is the front of the stand (B) (the rear cross plate has one cradle and one clamp). The front of the saw must face the front of the stand.

3. With the Compact Table Saw turned off and unplugged, place the saw on the stand with the frame in the cradles and the clamps.

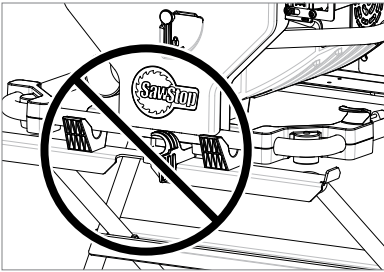

! Always orient the front of the saw to the front of the stand. Do not attempt to mount the saw as reversed or turned sideways. This illustration shows the back of the saw towards the front of the stand.

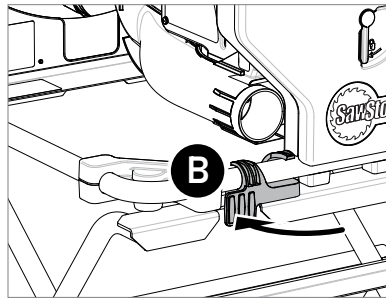
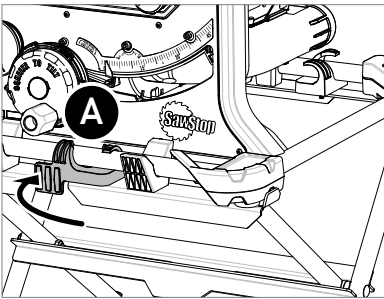

4. Close the front clamp (A). Close the rear clamp (B).

! Always make sure the clamps are locked before using the saw.

The stand is now ready to use.

How to Get Help



Main	503.570.3200 or 1.866.729.7867	info@SawStop.com
Technical Support (Service)	503.582.9934	service@SawStop.com
Parts	503.486.6923	parts@SawStop.com
Sales	503.595.2665	sales@SawStop.com

Our technical support team is standing by Monday-Friday, 7am-5pm Pacific Time.

You can download this manual at: SawStop.com/CTSsupport

SawStop, LLC

11555 SW Myslony Street, Tualatin, Oregon 97062 USA

www.SawStop.com

